

Catalogue



Partner of gastronomy

Catering equipment



Transport and output equipment



Output lines and self-service lines



Tray set systems



Isothermal containers

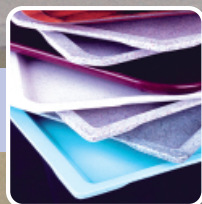

Trays



GN containers



Valid from 1. 7. 2019



Contents **Tray set systems**



- 2 - 8 Type THERMOLINE
 - 9 ETP - conveyors
- 10 - 11 Type ACTIVE-TRAY GN A0
- 12 - 13 Type COMBISET
- 14 - 15 Type THERMOSET
- 16 - 17 Type ABNER
- 18 - 19 Type MENÜ MOBIL
- 20 - 21 Polypropylene and melamin dishes
- 22 - 23 Crockery for tray set systems
 - 24 Crockery for safe manipulation

Type THERMOLINE



Description:

The THERMOLINE tray system serves for meals distribution in hospitals, elderly homes etc. It combines variability of tray set systems with high maneuverability.

Moulded isothermal bottom and lid are made of polypropylene with PUR foam.

THERMOLINE enables transport of warm food using pre-heated china ware and insulated bottoms and lids. Spill-safe soup bowl with inner rim ensures tight closing using special lid.

THERMOLINE could be used with or without Euronorm tray made of fibreglass.

Utilization:

Crockery is being pre-heated up to 85 – 90 °C and soup and main course are filled at minimum temperature 85 °C.

The meal remains at the right temperature up to 45 minutes.

Item	Item Nr.	Description
Insulated bottom THERMOLINE with magnet	29101	Synthetic bottom part 510×255 mm with built in magnet on the short side
Insulated lid THERMOLINE	29000	Synthetic lid 510×255 mm
Plate 230 THERMOLINE	29024	Porcelain ø 230 mm, flat bottom
Plate lid	29030	Synthetic lid for plate Nr. 29024 (polypropylene)
Soup bowl 121 THERMOLINE	29029	Porcelain ø 124 mm, capacity 0,36 l, flat bottom
Soup bowl lid THERMOLINE	29025	Synthetic lid for soup bowl Nr. 29029 (polypropylene)
Salad bowl 120	25532	Porcelain bowl ø 120 mm, capacity 0,25 l
Magnetic card holder	29065	Synthetic holder with magnet, 40×18×28 mm
Basic set total		

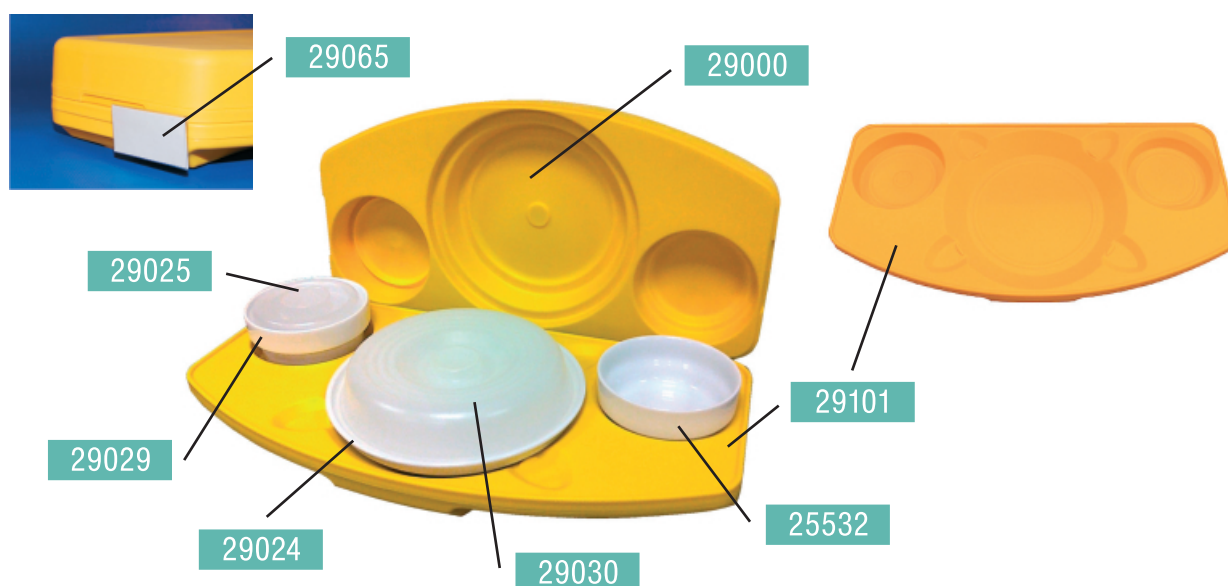

Type THERMOLINE

	Alternative parts	Item code
NEW	Soup bowl for silicone lid, porcelain, flat bottom	29049
NEW	Silicone soup bowl lid (for item 29049)	29048
NEW	Polypropylene soup bowl lid (for item 29049)	29060



29049



29048



29060

THERMOLINE accessories	Item code	Description
Tray THERMOLINE	29001	Fibre-glass laminated tray 530×370 mm
Card holder THERMOLINE	29020	Synthetic card holder
Salad bowl lid	29054	Synthetic lid for bowl Nr. 25532 (polypropylene)
Handbasket for 3 pcs of tablet	11927	Stainless steel
Insulated pair of gloves for manipulation with pre-heated dishes	29047	Size S, M, L, XL

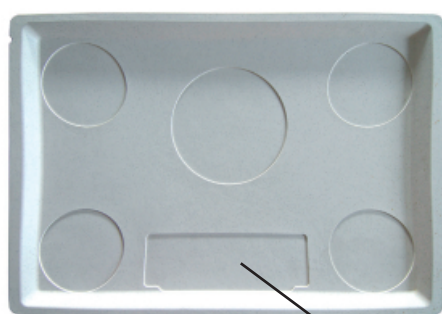

29001



29020



29054



11927



29047

Type THERMOLINE A1 – ACTIVE HEATING

- active heating of plate with main meal only



Description:

The THERMOLINE A1 and A2 tray system was specially developed for cook & serve catering. Great attention has been given to the new requirements in the field of hygiene. The result is a user-friendly system which maintains an optimum temperature. The heating system of the THERMOLINE system has been adjusted to a foodtemperature of 65 - 75 °C. Each heating zone is regulated individually by means of a temperature sensor. This automatic heating system guarantees an even target temperature of all foods using the lowest power consumption. The heating module is covered with a lid made from polypropylene with PUR foam core. In this way an optimum insulation for hot foods is achieved and heat transfer to cold foods is prevented. Both the heating module and the lid are fully dishwasher proof.

Item	Item Nr.	Description
Insulated bottom THERMOLINE A1	29201	Synthetic bottom part 510×255 mm with magnet on short side
Insulated lid THERMOLINE	29000	Synthetic lid 510×255 mm
Plate 230 THERMOLINE	29024	Porcelain, ø 230 mm, flat bottom
Plate's lid	29030	Synthetic lid for plate Nr. 29024
Soup bowl 124 THERMOLINE	29029	Porcelain, ø 124 mm, capacity 0,36 l, flat bottom
Soup bowl lid THERMOLINE	29025	Synthetic lid for soup bowl Nr. 29029
Salad bowl 120	25532	Porcelain, ø 120 mm, capacity 0,25 l
Magnetic card holder	29065	Synthetic card holder with magnet (40×18×28 mm)
Basic set total		

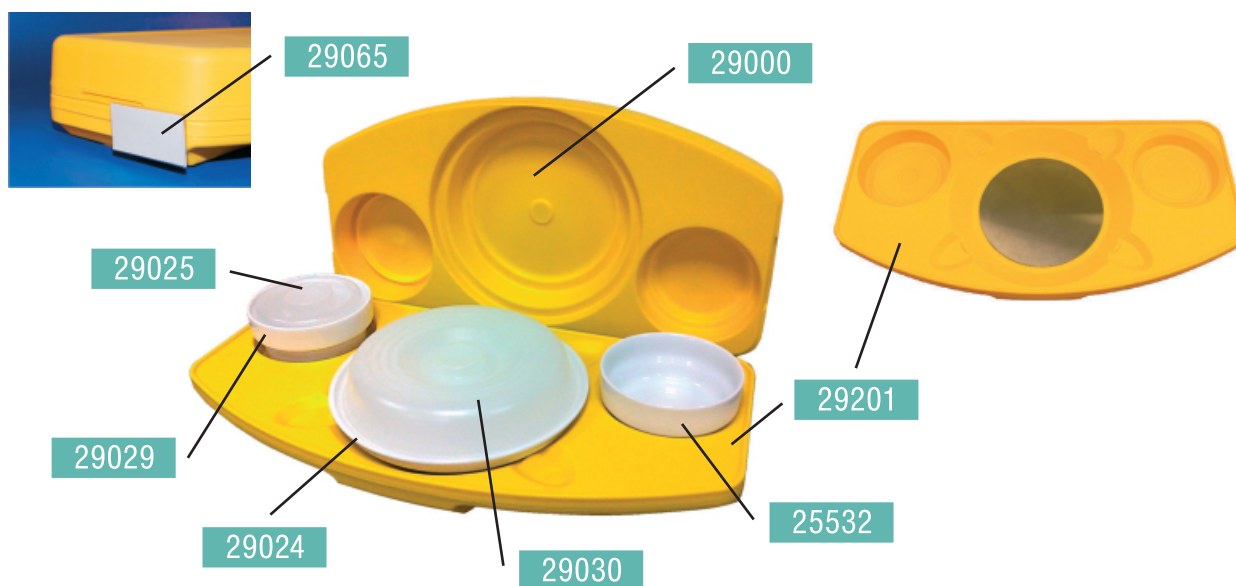

Type THERMOLINE A2 – ACTIVE HEATING

– active heating of plate with main meal and bowl with soup

Description:

The THERMOLINE A1 and A2 tray system was specially developed for cook & serve catering. Great attention has been given to the new requirements in the field of hygiene. The result is a user-friendly system which maintains an optimum temperature. The heating system of the THERMOLINE system has been adjusted to a food temperature of 65 - 75 °C. Each heating zone is regulated individually by means of a temperature sensor. This automatic heating system guarantees an even target temperature of all foods using the lowest power consumption. The heating module is covered with a lid made from polypropylene with PUR foam core. In this way an optimum insulation for hot foods is achieved and heat transfer to cold foods is prevented. Both the heating module and the lid are fully dishwasher proof.



Item	Item Nr.	Description
Insulated bottom THERMOLINE A 2	29301	Synthetic bottom part 510×255 mm with magnet on short side
Insulated lid THERMOLINE	29000	Synthetic lid 510×255 mm
Plate 230 THERMOLINE	29024	Porcelain, Ø 230 mm, flat bottom
Plate's lid	29030	Synthetic lid for plate Nr. 29024, Ø215 mm, h. 35 mm
Soup bowl 124 THERMOLINE	29029	Porcelain, Ø 124 mm, capacity 0,36 l, flat bottom
Soup bowl lid THERMOLINE	29025	Synthetic lid for soup bowl Nr. 29029, Ø115 mm, h. 16 mm
Salad bowl 120	25532	Porcelain, Ø 120 mm, capacity 0,25 l
Magnetic card holder	29065	Synthetic card holder with magnet (40×18×28 mm)
Basic set total		

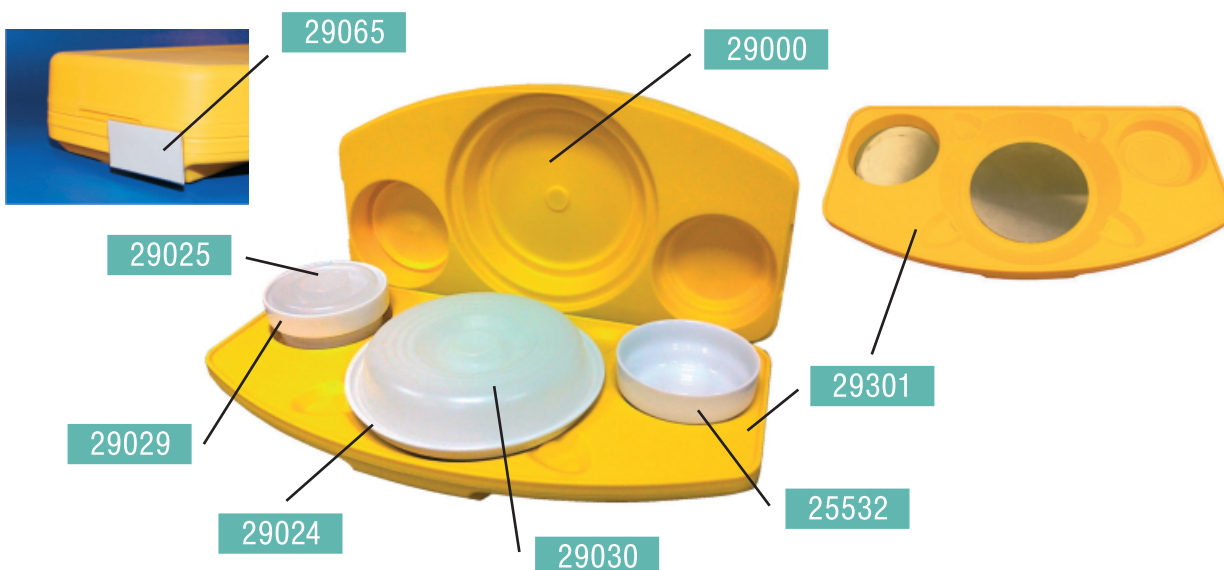

Type THERMOLINE A1, A2 - ACTIVE HEATING

Alternative parts	Item code	
Soup bowl for silicone lid, porcelain, flat bottom	29049	NEW
Silicone soup bowl lid (for item 29049)	29048	NEW
Polypropylene soup bowl lid (for item 29049)	29060	NEW



29049



29048



29060

THERMOLINE A1 & A2 accessories		Item code
Tray THERMOLINE	Fibre-glass laminated tray 530×370 mm	29001
Card holder THERMOLINE	Synthetic card holder	29020
Salad bowl lid	Synthetic lid for bowl Nr. 25532 (polypropylene)	29054
Tray Thermoline 530×370 with adapter	Fibre-glass laminated tray	29039 NEW
Insulated pair of gloves for manipulation with pre-heated dishes	Size S, M, L, XL	29047

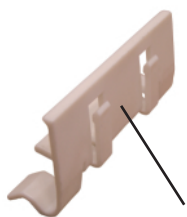

29020



29054

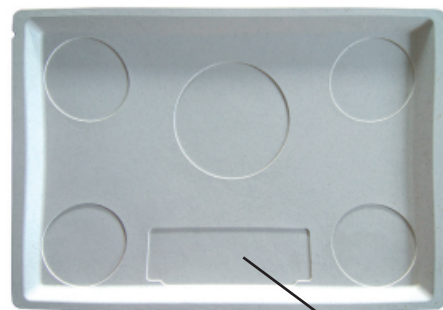

29001



29047

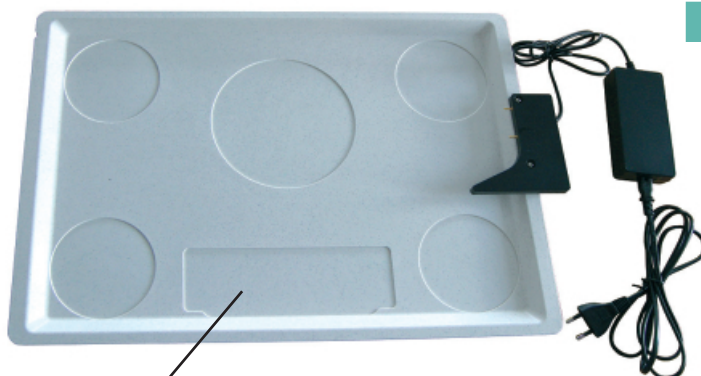

29039

NEW

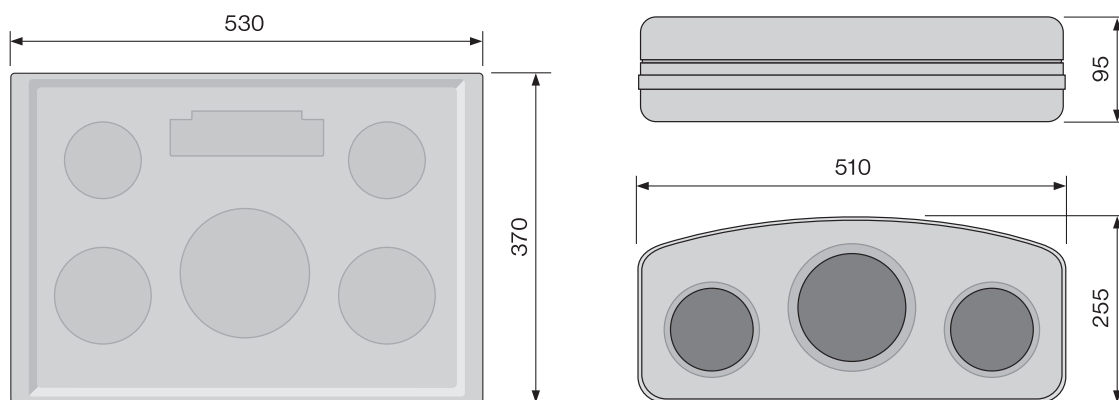

29001 Tray THERMOLINE 530×370

TABLET THERMOLINE

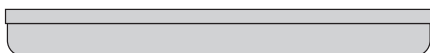
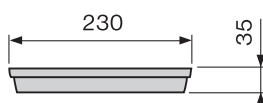

29000 Insulated lid THERMOLINE 510×255

29101
29201 A1
29301 A2 Insulated bottom THERMOLINE 510×255

29024 Plate 230 THERMOLINE, flat bottom porcelain

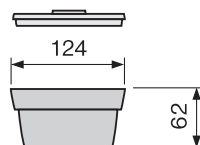

29029 Soup bowl THERMOLINE, flat bottom 0,36 l

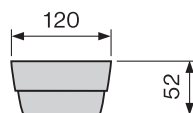

25532 Salad bowl 0,25 l

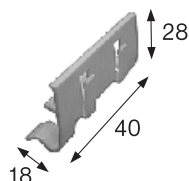

29020 Card holder THERMOLINE plastic

Type THERMOLINE

Washing baskets

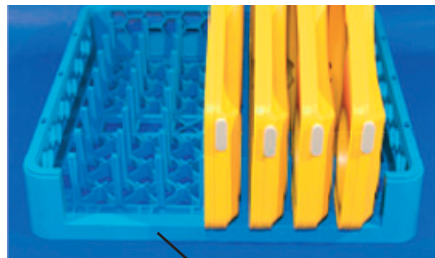

29004



29005

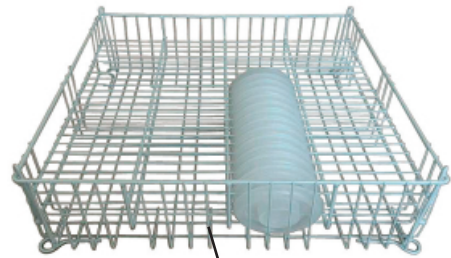

20932

Washing baskets	Item code	Description
Washing basket 500×500×102	29004	Capacity 7 pcs of bottom parts of THERMOLINE
Washing basket 500×500×146	29005	Capacity 5 pcs of lids of THERMOLINE
Washing basket for lids 500×500×130	20932	Capacity 92 pcs of plastic lids 29025

Recommended equipment	Transport equipment catalogue	
Trolleys NET	page 16	Transport of tablets
Trolleys TTV	page 14, 15	Transport of tablets
Trolleys TTV A	page 17, 18	Transport of tablets
Trolley RV 5	page 33	Storing and transport of THERMOLINE's bottoms and lids
Trolley EPT	page 23	Plate deep
Trolleys EPU	page 23	Soup bowls / Plate deep
Trolley PK, PN	page 28	Salad bowls

Type ETP



Description:

- the conveyor is made from stainless steel 18/10
- dimensions: length = according to customer's request (max. 14000 mm);
width = 500 mm; belt width = 400 mm
- optical closing
- fluent speed control
- emergency stop button
- power supply: 230 V ~ 50 Hz or 400 V ~ 50 Hz

Utilization:

The conveyors are intended for transport of tablet components (trays, plates, bowls, etc.)

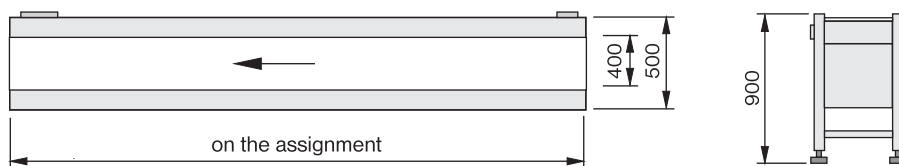
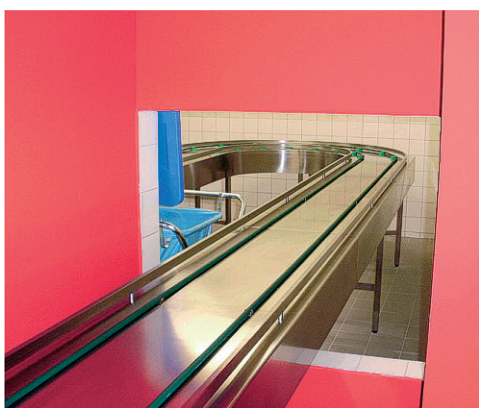

Item	Length (mm)	Width (mm)	Expedition (m/min.)	Engine power (kW)
ETP	max. 14 m	400	0-10	0,5

Typ ACTIVE-TRAY GN AO

NEW

NEW

Utilization:

Crockery is being pre-heated up to 85–90 °C and soup and main course are filled at minimum temperature 85 °C. The meal remains at the right temperature up to 45 minutes.

Description:

The Active-Tray both tray and lid are shell constructed of polypropylene and insulated with polyuretane foam. These materials are not harmful and they are suitable for food contact.

On the tray are spaces for main meal plate, soup bowl, cutlery and salad bowl or glass included.

The lid covers main meal plate and a soup bowl with its own polypropylene lid.

Card holder for easy identification added.

Item	Item Nr.	Description
Active-Tray GN AO	29206	Insulated tray made of polypropylene, 530×325 mm
Active-Tray lid	29218	Common lid for soup bowl and main meal plate, made of polypr., insul.
Soup bowl	29029	Porcelain bowl, capacity 0,36 l, ø 124 mm, flat bottom
Soup bowl lid	29025S	Synthetic lid for soup bowl Nr. 29029, made of polypropylene
Plate	29024	Porcelain plate, ø 230 mm, flat bottom
Salad bowl	25532	Porcelain bowl, capacity 0,25l, ø 120 mm
Basic set total		
Doplňkové díly:		
Salad bowl lid	29054	for bowl 25532, made of polypropylene
Card holder	29020	plastic

NEW

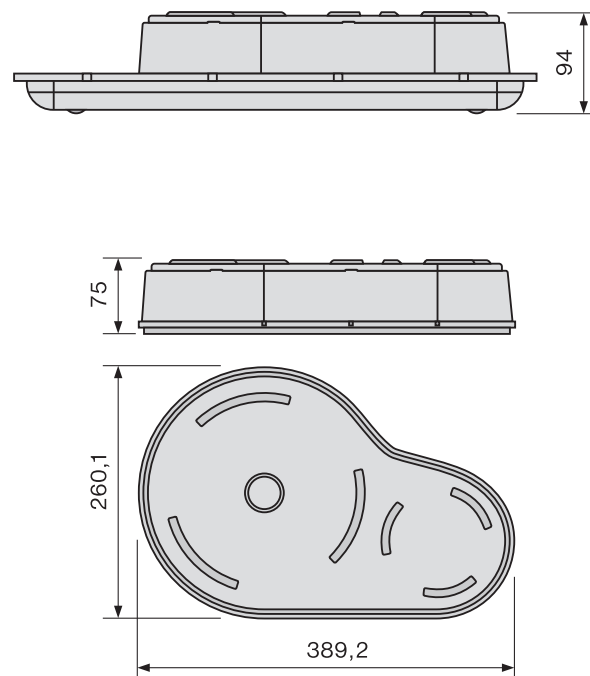
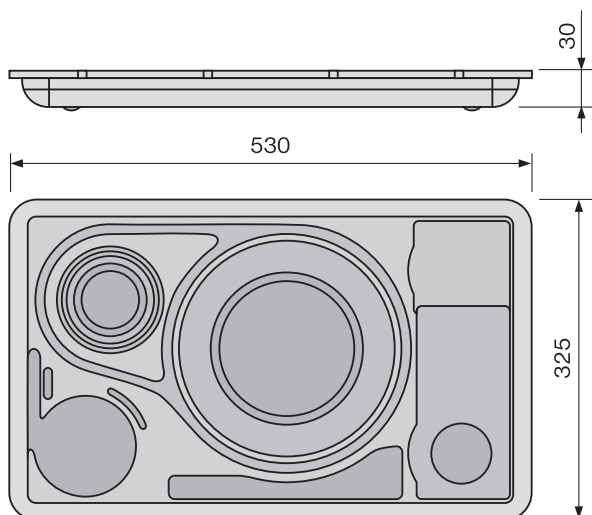
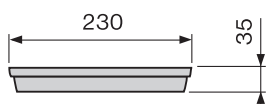
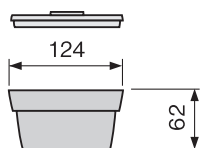
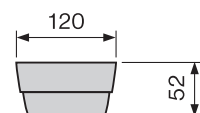
NEW**TABLET Active-Tray GN AO**29218 **Active-Tray GN AO insulated tray**29206 **Active-Tray GN AO insulated common lid**29024 **Main meal plate, flat bottom** porcelain29029 **Soup bowl, flat bottom, capacity 0,36 l** porcelain25532 **Salad bowl, capacity 0,25 l** porcelain

Additional parts

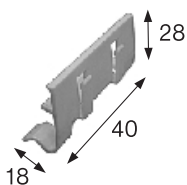
29020 **Card holder** plastic

Type COMBISET



Description:

This tablet offers large warm-keeping part for plate with \varnothing 260 mm (or three-compartment plate). Places for side-dishes and the cutlery part are also covered. The excellent insulation and the precisely formed labyrinth-joint between lid and bottom guarantee long time warm-keeping.

Utilization:

Hot meals are portioned freshly cooked, in high temperatures (about 85 °C), on pre-heated crockery of about 90 °C. COMBISET then keeps the meals warm up to 45 minutes.

Item	Item Nr.	Description
Tray COMBISET SD	28301	Polypropylene insulated bottom part
Tray COMBISET HD	28301A	Polypropylene insulated lid
Plate	25523	China plate \varnothing 260 mm
Soup bowl with lid	60017	Polyprop. ins. bowl \varnothing 110 mm with non-insulated lid, capacity 0,3 l
Trimming bowl	29046	Square porcelain bowl 175×110×37 mm, capacity 0,2 l
Basic set total		
Additional and alternative parts of COMBISET		
Salad bowl	28304	Square porcelain bowl 90×120×30 mm, capacity 0,1 l
Coffee cup	28315	Polypropylene insulated cup without lid, capacity 0,14 l
Coffee cup lid	28316	Polypropylene lid with mouthpiece
Coffee cup lid	28316A	Polypropylene lid with mouthpiece and small hole
Coffee cup lid	28318	Polypropylene lid without mouthpiece
Two-part plate 254	25607	Porcelain plate \varnothing 254 mm with 2 separate portions, height 32 mm
Three-part plate 255	25609	Porcelain plate \varnothing 255 mm with 3 separate portions, height 28 mm
Thermal insert HOTSET	28296	Stainless steel capsule filled with wax (under the plate)
Insulated pair of gloves for manipulation with pre-heated dishes	29047	Size S, M, L, XL
Recommended equipment Transport equipment catalogue		
Trolley RV 4	page 33	Storing and transp. of COMBISET's bott. and lids
Trolley EPT 2	page 23	Storing and pre-heating of plates
Trolley PK 500×500	page 28	Storing of soup bowls/salad bowls
Trolley PN 580×580		Storing of soup bowls/salad bowls
Trolleys TTV-E	page 14-15	Transport of tablets
Trolleys TTV-D		

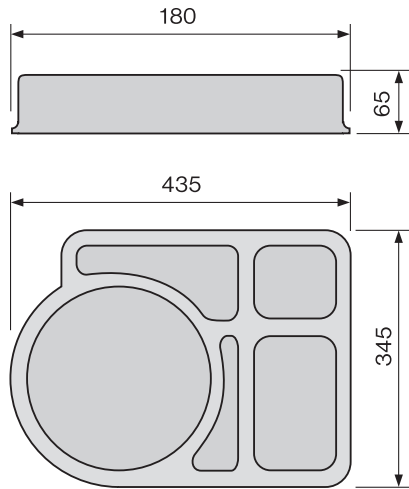

28301A Tray COMBISET HD

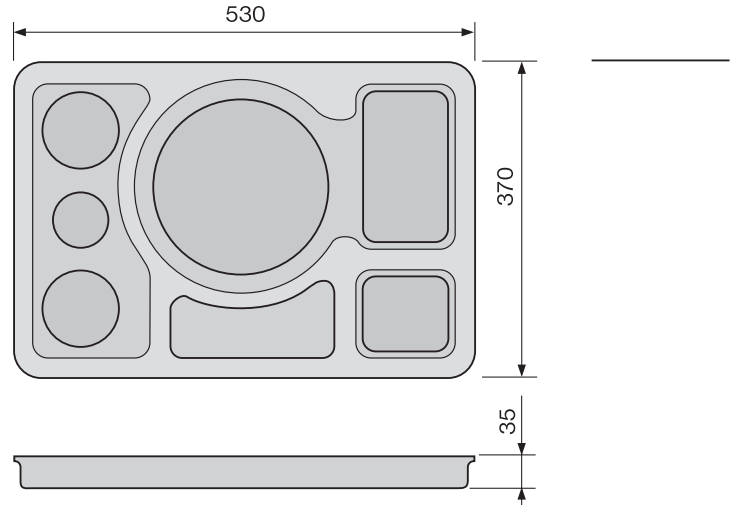

28301 Tray COMBISET SD

TABLET COMBISET

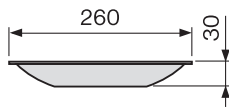

25523 Plate ø 260

capacity PS 290: 50 pcs

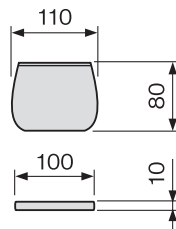

60017 Soup bowl with lid

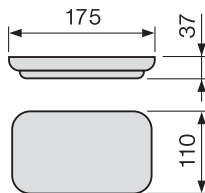

29046 Trimming bowl

capacity basket 650×530×115: 160 pcs

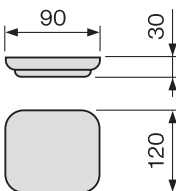

28304 Salad bowl

capacity basket 500×500×115: 80 pcs

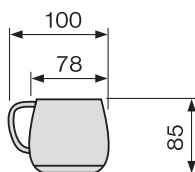

28315 Coffee cup

capacity PN 580×580: 360 pcs

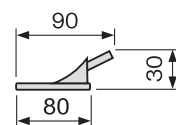

28316 Coffee cup lid

with mouthpiece

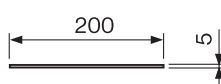

28296 Thermal insert HOTSET

Type THERMOSET



Description:

Insulated bottom and lid for plates with \varnothing 260 mm (or three-compartment plate), china salad bowl, insulated polypropylene soup bowl with lid.

Utilization:

Hot meals are portioned freshly cooked, in high temperatures (about 85 °C), on pre-heated crockery of about 90 °C. THERMOSET then keeps the meals warm up to 45 minutes.

Item	Item Nr.	Description
Insulated cover THERMOSET	28300	Polypropylene insulated parts (bottom + lid)
Plate	25523	Porcelain plate \varnothing 260 mm
Soup bowl with lid	60017	Polyprop. insulated bowl \varnothing 110 mm with non-insulated lid, capac. 0,3 l
Salad bowl 120	25532	Porcelain bowl \varnothing 120 mm, capacity 0,25 l
Tray GLASS EURONORM	60712	Fibre-glass laminated tray 530×370 mm, melange red/blue
Card holder	18022	Stainless steel
Basic set total		
Additional and alternative parts of THERMOSET		
Two-part plate 254	25607	Porcelain plate \varnothing 254 mm with 2 separate portions, height 32 mm
Three-part plate 255	25609	Porcelain plate \varnothing 255 mm with 3 separate portions, height 28 mm
Coffee pot	28309	Polypropylene, capacity 0,28 l
Coffee pot lid	28311	Polypropylene
Thermal insert HOTSET	28296	Stainless steel capsule filled with wax (under the plate)
Soup bowl 140 THERMOSET	28306	Porcelain bowl \varnothing 140 mm, capacity 0,46 l, suitable for cover Nr. 25613
Cover for soup bowl THERMOSET	25613	Polypropylene insulated parts (bottom + lid) for bowl Nr. 28306
Insulated pair of gloves for manipulation with pre-heated dishes	29047	Size S, M, L, XL

TABLET THERMOSET

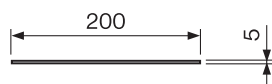
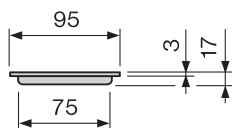
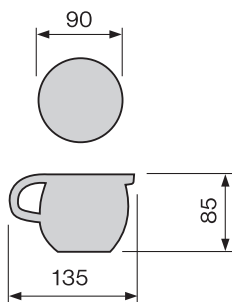
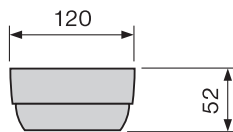
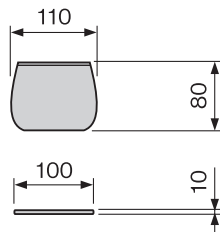
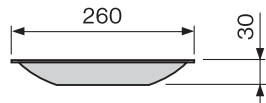
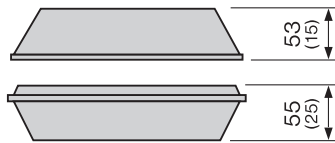
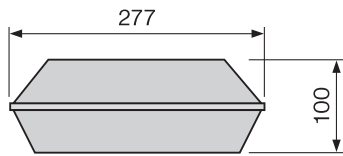

28300 Insulated cover THERMOSET

25523 Plate \varnothing 260

capacity PS 290: 50 pcs

60017 Soup bowl with lid

25532 Salad bowl 120

capacity PS 285×285: 100 pcs

28309 Coffee pot

28311 Coffee pot lid

28296 Thermal insert HOTSET

Type **ABNER** made of stainless steel

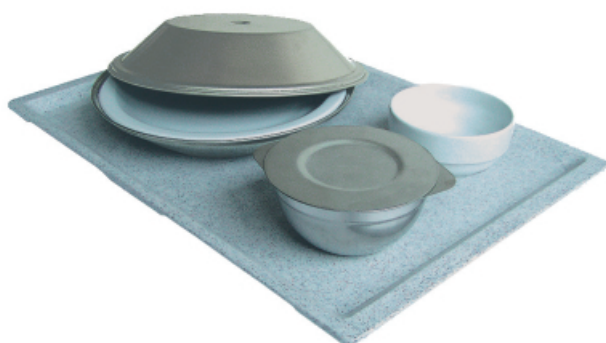

Description:

This type of tablet consists of insulated stainless steel bottom for porcelain plate with \varnothing 260 mm, stainless steel lid, stainless steel insulated (double-walled) soup bowl with stainless steel insulated (double-walled) lid, china salad bowl without lid and stainless steel card holder. All components lay on fibreglass thermostable Euronorm tray.

Utilization:

Hot meals are portioned freshly cooked, in high temperatures (about 85° C), on pre-heated crockery of about 90° C. The stainless steel bottom and soup bowl has been pre-heated too. ABNER then keeps the meals warm up to 45 minutes.

Item	Item Nr.	Description
Insulated pan for plate	28001	Stainless steel pan \varnothing 275 mm
Pan cover	28000	Stainless steel cover \varnothing 290 mm
Soup bowl insulated	25511	Stainless steel bowl \varnothing 125 mm, capacity 0,3 l
Soup bowl lid insulated	25512	Stainless steel \varnothing 137 mm
Plate	25523	Porcelain plate \varnothing 260 mm
Salad bowl 120	25532	Porcelain bowl \varnothing 120 mm, capacity 0,25 l
Tray GLASS EURONORM	60712	Fibre-glass lamin. tray 530×370 mm, melange red/blue
Card holder	18022	Stainless steel
Basic set total		
Additional and alternative parts of ABNER		
Soup bowl single-walled	25513	Stainless steel bowl \varnothing 125 mm, capacity 0,4 l
Soup bowl lid single-walled	25514	Stainless steel \varnothing 137 mm
Salad bowl	25510	Stainless steel \varnothing 130 mm, capacity 0,2 l
Two-part plate 254	25607	Porc. plate \varnothing 254 mm with 2 sep. portions, h. 32 mm
Three-part plate 255	25609	Porc. plate \varnothing 255 mm with 3 sep. portions, h. 28 mm
Insulated pair of gloves for manipulation with pre-heated dishes	29047	Size S, M, L, XL
Recommended equipment Transport equipment catalogue		
Trolley NKPP 370×530	page 29	Storing of tray Glass Gastronorm
Trolley PK 500×500	page 28	Storing of soup bowls/salad bowls
Trolley EPT 2	page 23	Storing and pre-heating of plates
Trolley EPK 500×500	page 28	Storing and pre-heating of soup bowls/salad bowls
Trolley EPN 580×580		Storing and pre-heating of soup bowls/salad bowls
Trolleys TTV-E 2×10 (3×10)	page 14-15	Transport of tablets, single-walled or double-walled, insulated
Trolleys TTV-D 2×10 (3×10)		
Trolley ETV 1-20 2×(530×375)	page 19	Transport of tablets, double-walled, insulated, heated



TABLET ABNER

60712 Tray GLASS EURONORM (530×370)

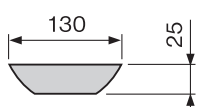
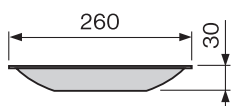
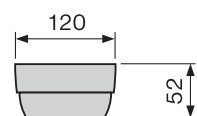
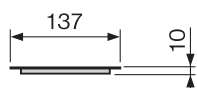
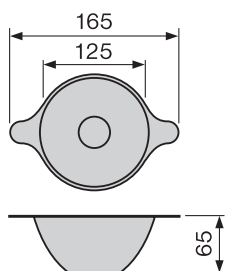
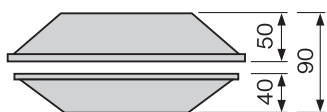
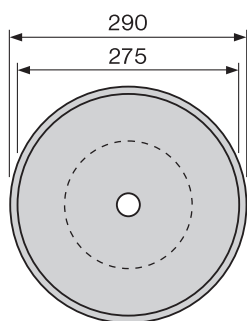

28000 Pan cover capacity PS 290: 130 pcs

28001 Insulated pan for plate capacity PS 290: 50 pcs

25511 Soup bowl insulated capacity PS 285×285: 260 pcs

25512 Soup bowl lid insulated

25532 Salad bowl 120 capacity PS 285×285: 100 pcs

25523 Plate \varnothing 260 capacity PS 290: 50 pcs

25510 Miska na salát

Type MENÜ MOBIL



Description:

In MENÜ MOBIL tablet hot and cold menu components can be served simultaneously yet are perfectly insulated from each other. The spill-safe inner lid prevents meal components from spilling or running together and a unique slide lock guarantees absolute safety against sliding or slipping - even on the most difficult transport routes.

Utilization:

Hot meals are portioned freshly cooked, in high temperatures (about 85 °C), on pre-heated crockery of about 90 °C. The lids should be pre-heated up to 23 °C. MENÜ MOBIL then keeps the meals warm up to 90 minutes.

Washing temperature max. 85 °C!

Item	Item Nr.	Description
Set insulated MM	33014	Synthetic insulated parts of tablet (bottom + lid)
Plate 215 MM	33029	Porcelain plate ø 215 mm
Plate lid MM	33018	Synthetic, yellow
Soup bowl 111 MM	33015	Porc. bowl ø 111 mm, cap. 0,35 l (2 pcs/tablet)
Bowl lid MM	33019	Synthetic, yellow (2 pcs/tablet)
Tablet lock MM	33033	Synthetic, black
Basic set total		
Additional and alternative parts of MENÜ MOBIL		
Salad bowl MM	33016	Porcelain bowl ø 111 mm, capacity 0,18 l
Two-part plate 213 MM	33017	Porcelain plate ø 213 mm with 2 separate portions
Three-part plate 214 MM	33047	Porcelain plate ø 214 mm with 3 separate portions
Thermal insert MM	28350	Stainless steel (under the plate)
Handbasket for 4 pcs of tablet	33021	Stainless steel wires
Insulated pair of gloves for manipulation with pre-heated dishes	29047	Size S, M, L, XL
Additional and alternative parts of MENÜ MOBIL - melamin dishes		
Plate MM	30003	Melamin, ø 215 mm, h. 40 mm
Two-part plate MM	30015	Melamin, ø 215 mm, with 2 separate portions
Plate's lid MM	30004	Synthetic lid for plate Nr. 30003 and 30015, yellow
Soup bowl MM	33035	Melamin, ø 110 mm, capacity 0,35 l, h. 70 mm
Salad bowl MM	33036	Melamin, ø 110 mm, capacity 0,18 l, h. 35 mm
Recommended trolleys		
ETV 11193	NEK 90729	NET 11815
11268	90730	
	90749	

TABLET MENÜ MOBİL

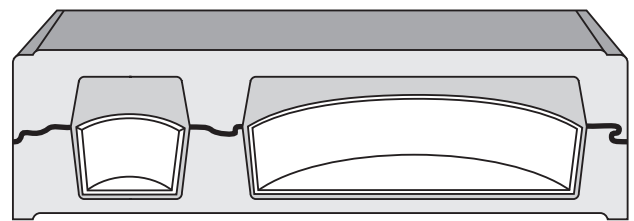
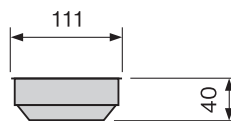
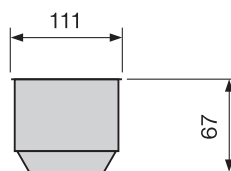
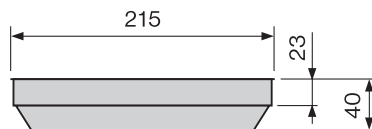
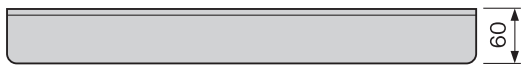
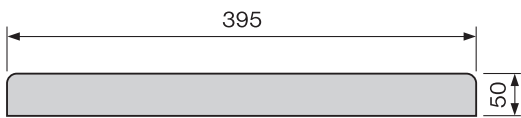
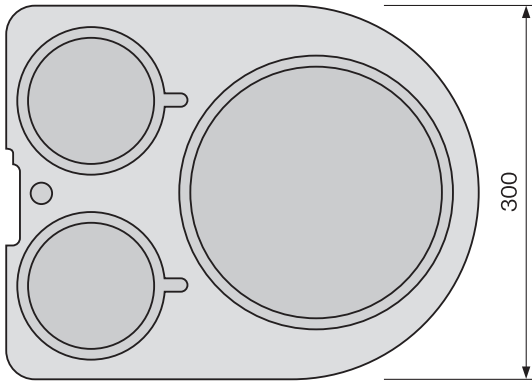

33014 Insulated cover MM - upper part

capacity RV 4: 104 pcs

33014 Insulated cover MM - lower part

capacity RV 4: 84 pcs

33029 Plate 215 MM

capacity PS 290: 33 pcs

33015 Plate 215 MM

capacity PS 285: 56 pcs

33016 Salad bowl MM

Cutlery







Item Nr.	Description
25517	Spoon
25518	Fork
25519	Knife
25524	Teaspoon

Polypropylene and Melamin dishes

Item Nr.	Item picture	Color	Capacity (ml)	Height (mm)	Diameter (mm)	Weight (g)
Soup bowl with lid						
60017		white	300	80	109	106
60017H		brown				
60017H0		brown/orange				
60017Ž0		yellow/orange				
60017P		sand				
Tea-cup/Coffe-cup without lid						
28315		white	140	83	85	62
28315H0		brown/orange				
28315Ž0		yellow/orange				
28315MB		blue/white				
28315HB		brown/white				
28315ŽB		yellow/white				
Lid without mouth-piece						
28318		white	-	-	-	-
Lid with mouth-piece - larger diameter						
28316		white transparent	-	-	-	-
Lid with mouth-piece - smaller diameter						
28316A		blue transparent	-	-	-	-
Tea-pot/Coffe-pot wit lid						
28309		white	280	87	95	102
28309H		brown				
28309H0		brown/orange				
28309HB		brown/white				
28309MB		blue/white				
28309Ž0		yellow/orange				
Tea-pot/Coffe-pot wit lid						
28323		white	310	97	95	115
28323H		brown				
28323HB		brown/white				
Melamin soup bowl						
33035		white	400	70	110	-

Polypropylene and Melamin dishes

Item Nr.	Item picture	Color	Capacity (ml)	Height (mm)	Diameter (mm)	Weight (g)
Melamin salad bowl						
33036		white	180	35	110	-
Synthetic lid small for soup, salad bowl						
33019		yellow	-	-	-	-
Melamin dinner plate undivided						
30003		white	-	40	215	-
Melamin dinner plate divided						
30015		white	-	40	215	-
Synthetic lid large for dinner plate						
30004		yellow	-	-	-	-

Polypropylene dishes

Description:

- double-walled insulated
- dish-washer proof
- wash at 100 °C max. for 2 minutes
- alkali-proof
- colour-fast
- unsuitable for using in ovens or chillers
- suitable for using in MW ovens (max. 3 min.)
- Lids (with/without mouth-piece) do not use in MW ovens
- fulfill sanitary standards

Use:

Jug - hold the lid by your toe during manipulation and pouring
 Bowl with small lid - to remove lid spin it a little.
 Lids with/without mouth-piece - abut on the cups in order to achieve optimal tightness (it is recommended to pre-heat up to 23 °C before use, e. g. in warm water).

Melamin dishes







Description:

- unbreakable
- recommended temperatures - should not be exceeded:
 - 1) short-time (max. 20 sec.) 150 °C - 200 °C
 - 2) medium-term (max. 20 sec.) 100 °C - 120 °C
 - 3) long-term (continually) 80 °C - 100 °C
- not alkali-proof
- fulfill sanitary standards

Use:



- use common detergents for washing
- never use scouring powder or any other abrasive
- avoid exposure to hot objects, and prolonged exposure to boiling water
- do not use in MW oven!

Chinaware for tablet systems







Item Nr.	Picture	Description	Usable in	Packing pcs.
29024		Plate deep with mounting and flat bottom diam. 230 mm	THERMOLINE, TEMP-ROYAL (plate without lid) The convex shape is ideal for uneven terrain and prevents spillage when transporting food	3
25523		Plate flat diam. 260 mm	COMBISET, ABNER, THERMOSET, TEMP-ROYAL, RIEBER-THERMOTRAY (even for cloche) suitable for free sale	3
25604		Plate semi-deep diam. 255 mm	Suitable for free sale	3
25607		Dinner plate divided diam. 255 mm	COMBISET, ABNER, THERMOSET	3
25609		Dinner plate three-parts divided diam. 255 mm	COMBISET, ABNER, THERMOSET	3
29019		Dinner plate diam. 230 mm	Suitable for free sale	6



For designed chinaware for THERMOLINE tablet system contact our Sales department.

Item Nr.	Picture	Description	Usable in	Packing pcs.
29029		Soup bowl with mounting and flat bottom diam. 124 mm	THERMOLINE	6
25532		Salad bowl 0,25 l diam. 120 mm	THERMOLINE, COMBISET, ABNER, THERMOSET, Suitable for free sale	6
25606		Porcelain bowl 0,50 l diam. 121 mm	Suitable for free sale	6
25612		Salad bowl, deep 0,43 l	Suitable for free sale	6
25613		Soup bowl diam. 140 mm	THERMOSET for complet Nr. 28306	6
25608		Compote bowl diam. 190 mm	Suitable for free sale	4
33029		Plate undivided diam. 215 mm	MENU MOBIL	3
33017		Plate divided diam. 213 mm	MENU MOBIL	3
33047		Plate divided diam. 214 mm	MENU MOBIL	3
33015		Bowl 0,35 l diam. 111 mm	MENU MOBIL	6
33016		Bowl 0,18 l diam. 111 mm	MENU MOBIL	6

Chinaware for safe manipulation for handicapped people in hospitals, rest homes, institutes of social services

Item Nr.	Picture	Description	Usable in	Packing pcs.
29120		Plate semi-deep diam. 260 mm	Optimal design with its pronounced curb between inner edge and internal face allows a safe collecting of the food, especially for handicapped people. Concave rim allows a safe grip. Intelligent shape ensures best stack ability, safe transport and easy handling.	6
29121		Plate deep diam. 230 mm	Optimal design with its pronounced curb between inner edge and internal face allows a safe collecting of the food, especially for handicapped people. Concave rim allows a safe grip. Intelligent shape ensures best stack ability, safe transport and easy handling.	6
29122		Mug 0,30 l	Wide opening makes drinking easier Optimal size combined with an angle between top and side edge makes the handle perfect to grab and hold	6
29123		Saucer diam. 170 mm	Special design of the saucer makes possible that the cup slips back into the saucer hollow in the center without spilling out its content	6
29124		Cup padded high 030 l diam. 82 mm high 89 mm	Large diameter makes it easy to drink cup. Ergonomic ears and the optimal shape of the cup ensures perfect grip	6
29125		Saucer padded diam. 250 mm shallow	Suitable free for sale	6

NEW

For color variations of chinaware please contact our Sales department.



Selected references:

Cafeterias

BIBUS Brno
Restaurace Stuttgart (DE)
Autobusový terminál Szekesfehervar (HU)
Restaurace Heilderberg (DE)
Gastrocentrum Vyškov
Restaurace Šumperk
VGJŽ Mor. Třebová
GLOBUS ČR
JAHA Mor. Třebová
Catering Pressl Nýrsko
OKD Ostrava
POPELKA Brandýs n. Labem
Nová Karolína Ostrava
Záložna Přelouč
ŠRZ Velký Meder (SK)

Hospitals

Znojmo
Slezská nemocnice Opava
Velký Krtíš (SK)
Žlutý Kopec Brno
Saalfeld (DE)
Třebíč
Dvůr Králové n. L.
Hodonín
Tanvald
Pardubice
Praha - Krč
Kolín
Liberec
Náchod
Bratislava (SK)
Košice (SK)
Snina (SK)
MN Ostrava
Polička
IKEM Praha
Psych. nemocnice Brno

Industrial canteens

Miele Uničov
Ostroj Opava
OKD Bastro Ostrava
HMMC Nošovice
Logistické centrum Šmidl
Vysoké Mýto
Zentiva Praha
Linaset Budišov
SMC Vyškov
Ammann Nové Město n. Metují
HELLA Mohelnice
KIEKERT Přelouč
SILON Planá n. Lužnicí
TEVA Opava
Autocentrum BARTH
Česká spořitelna Praha
KYB Manufacturing Pardubice
MILACRON Polička
SHM Šumperk
MODEL Opava

Tray set systems

Catalogue



ABNER a.s.

Václavské náměstí 56
110 00 Praha 1
Czech Republic

production, sales, warehouse
Lanškrounská 87
571 01 Moravská Třebová
Czech Republic
Tel.: +420 461 313 111
Fax: +420 461 313 171

www.abner.cz